







FITTING INSTRUCTIONS

(INCLUDING SPECIFIC OPERATING PRESSURES)

CR5139



-  This air suspension system is designed to assist the original vehicle manufacturer's suspension – it is not meant to carry the entire rated load. We do not recommend that the coil springs be altered from the OEM suspension specification; unless an applicable commercially available suspension kit is fitted.
-  The kit is designed to suit a standard vehicle configuration – modifications to the vehicle outside the kit design parameters may adversely affect fitment and operation such as:
 - Height changes outside any noted in the kit specification.
 - Larger dampers (Shock Absorbers)
 - Wheel and tyre changes
 - Exhaust changes.
-  If your vehicle is fitted with a brake proportioning valve or stability control system it is important to ensure this is maintained and adjusted according to the vehicle manufacturer's instructions.
-  It is recommended that only a properly qualified person installs the product and carries out maintenance. If you are not qualified and attempt to carry out such work ensure that all safety equipment is used and safety standards are met.
-  Ensure that you have read the full Product Manual before attempting to fit the product.
-  Ensure the Product Manual is kept with the vehicle and that any vehicle owner and/or operator are fully advised on the system and its operation before attempting to drive or operate it.



SEE OTHER WARNINGS AND IMPORTANT INFORMATION IN THE PRODUCT MANUAL

LHS = LEFT SIDE OF THE VEHICLE WHEN FACING FORWARD

STEP 1 - AIR LINE TUBING & FITTINGS - GENERAL NOTES

CUTTING

Only cut the airline tubing with a sharp blade making the cut as square as possible.

Always trim the tubing before re-inserting into the fitting.

-  If you use a sharp utility knife or razor blade great care must be taken in all cases not to cut yourself during this operation.

CONNECTING & REMOVING

To connect:

Push the freshly trimmed tubing into the fitting as far as possible.

To remove:

First release the air pressure from the system. To withdraw the tubing, push and hold the collar on the fitting away from the tube and pull out the tubing.

Hint In confined spaces an open ended spanner can be used to evenly depress the collar and remove the airline tubing.

CUT TUBING SQUARE WITH SHARP BLADE OR TUBE CUTTER

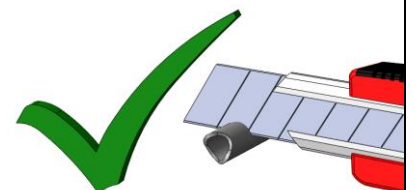

DO NOT USE PLIERS, SIDE CUTTERS OR PIPE CUTTERS

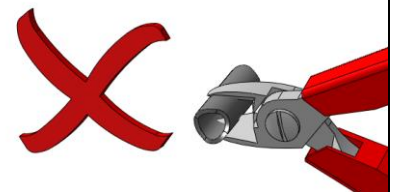

STEP 2 - POSITION YOUR INFLATION VALVES

Select a convenient location for the air inflation valves such as the bumper or the body of the vehicle. It must be protected from road damage and be accessible for air inflation equipment.

Drill a 5/16" hole and install the air inflation valve using two 5/16" stainless steel washers as supports where required.

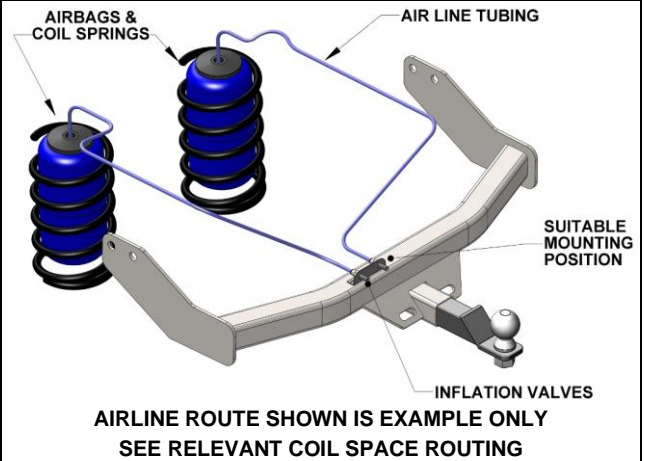
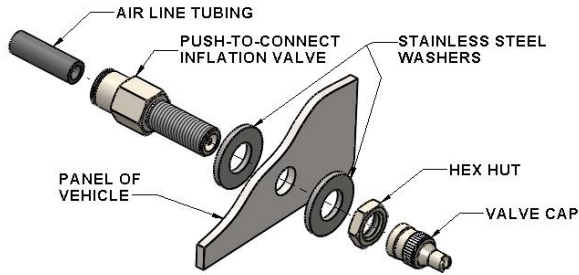

STEP 3 - PREPARE THE AIR LINE TUBING

The air line is supplied with split protector tube pre-fitted to shield the air line during and after installation. Decide on a suitable route for the air line from the airbag to the inflation valve location to avoid direct heat from engine, exhaust pipe, and away from sharp edges.

Uncoil the air line tubing being careful not to fold or kink it and cut to length to suit the chosen route. Once routed, the protector tube is pulled back later to prepare the protected air line.

DO NOT CONNECT OR SECURE THE AIR LINE AT THIS POINT



STEP 4 - PREPARE THE VEHICLE

In order to fit this kit the coil springs need to be extended. Ensure this operation is carried out according to the vehicle manufacturer's instructions.

STEP 5 - RED PLUGS

Use of the red plugs supplied is optional. They will enable a general reduction in airbag size which may be required to ease an airbag into a coil spring which is out of the vehicle, and they will fully flatten an airbag for easy insertion into an in-situ extended coil spring through the winding.

USING RED PLUGS: Flatten the airbag with the airline fitted and plug the other end of the airline tubing with the red plug. The airbag should now remain flattened whilst you perform fitment into the coil spring.

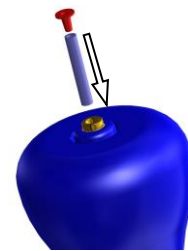

STEP 6 - AIRBAG INSTALLATION

Once the coils have been extended, fit the airbag into the coil with the air fitting facing down. For ease of fitment this can be achieved by the method in step 5.



STEP 7 - ROUTE THE AIRLINE TUBING INTO THE COIL SPACE

Route the airline tubing through the bottom of the coil spring seat with enough extra to protrude through the coil space for airbag connection and test.

The airline is to be routed at the rear of the axle running inboard to the differential center, up to the body, and then to the inflation points. The vehicle has factory lines and wires run in this path which can be used to ensure the correct airline routing and length.



STEP 8 - POSITIONING THE PROTECTOR

Position the air fitting protector on the air fitting end of the airbag, with the counter sunk hole facing the air fitting, as shown.

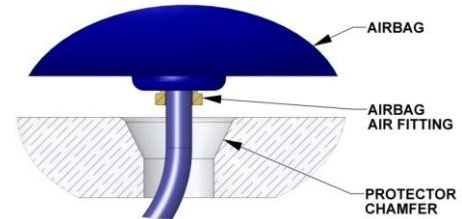

STEP 9 - CONNECT AIRLINE TUBING AND TEST CONNECTIONS

CONNECT the airline tubing by inserting one end into the airbag air fitting, the other end into the installed inflation valve.

Hint Flat nose pliers may be used to lightly grip the airline tubing to ensure it is fully inserted into the airbag fitting.

INFLATE the airbag to the maximum allowed pressure (See Specific Operating Pressure Advice attached) and check for leaks at the connections using soapy water spray. We recommend a soapy water spray solution of 25% soap to 75% water.

DEFLATE the airbag. If no leak, continue. If leak detected, remove the airline tubing, re-cut and re-test.

CHECK airbag is not in contact with any sharp edges or is too close to exhaust heat in all load and height conditions.

STEP 10 - INSTALL THE OPPOSING SIDE

Install the opposing side by following steps 4-9.

STEP 11 - INSTALL COMPLETION

Double check all components have been tightened up as per the manufacturer's specifications, then return the vehicle to its driving position. Ensure this operation is carried out according to the vehicle manufacturer's instructions.

STEP 12 - TO FINISH

Ensure the **WARNING** label is fixed in a prominent position in sight of the vehicle operator.
Ensure the Product Information Wallet is given to the vehicle owner/operator.
Ensure the vehicle owner/operator fully understands how to use the product.
All fixings should be checked for tightness after the first laden run and thereafter as per the original manufacturer's recommendations.

SPECIFIC AIRBAG OPERATING PRESSURES

See operating instructions section for proper use and apply the specific pressures below:

STANDARD KIT
WITHOUT HP SLEEVES

MINIMUM
5 PSI (0.4 bar)

MAXIMUM
30 PSI (2 bar)

**DID YOU KNOW WE OFFER HIGH
PRESSURE SLEEVE KITS TO SUIT
OUR COIL-RITE AIRBAGS?**

**WANT TO KNOW MORE ABOUT
HIGH PRESSURE SLEEVE KITS?**

**CALL AIRBAG MAN ON
FREECALL 1800 247 224**

Adjust and maintain pressure up to the stated maximum to level the vehicle for the load imposed and always maintain the minimum airbag pressure.

Failure to do so may result in product or vehicle damage not covered under warranty.

**IF MORE PRESSURE IS REQUIRED TO LEVEL THE VEHICLE
CALL AIRBAG MAN ON 1800 247 224 FOR FURTHER TECHNICAL ADVICE**



FREECALL 1800 247 224



⚠️ Incorrect use of this air suspension product can result in damage to the airbag, associated parts and/or the vehicle, which is not covered under warranty.

⚠️ Ensure the airbags are maintained at the stated ride height at all times and the maximum pressure is never exceeded.