

# FITTING INSTRUCTIONS

(INCLUDING SPECIFIC OPERATING PRESSURES)

## CR5009HP



- ⚠** This air suspension system is designed to assist the original vehicle manufacturer's suspension – it is not meant to carry the entire rated load. We do not recommend that the coil springs be altered from the OEM suspension specification, unless an applicable commercially available suspension kit is fitted.
- ⚠** The kit is designed to suit a standard vehicle configuration – modifications to the vehicle outside the kit design parameters may adversely affect fitment and operation such as:
  - Height changes outside any noted in the kit specification.
  - Larger dampers (Shock Absorbers)
  - Wheel and tyre changes
  - Exhaust changes.
- ⚠** If your vehicle is fitted with a brake proportioning valve or stability control system, it is important to ensure this is maintained and adjusted according to the vehicle manufacturer's instructions.
- ⚠** It is recommended that only a properly qualified person installs the product and carries out maintenance. If you are not qualified and attempt to carry out such work, ensure that all safety equipment is used, and safety standards are met.
- ⚠** Ensure that you have read the full Product Manual before attempting to fit the product.
- ⚠** Ensure the Product Manual is kept with the vehicle and that any vehicle owner and/or operator is fully advised on the system and its operation before attempting to drive or operate it.

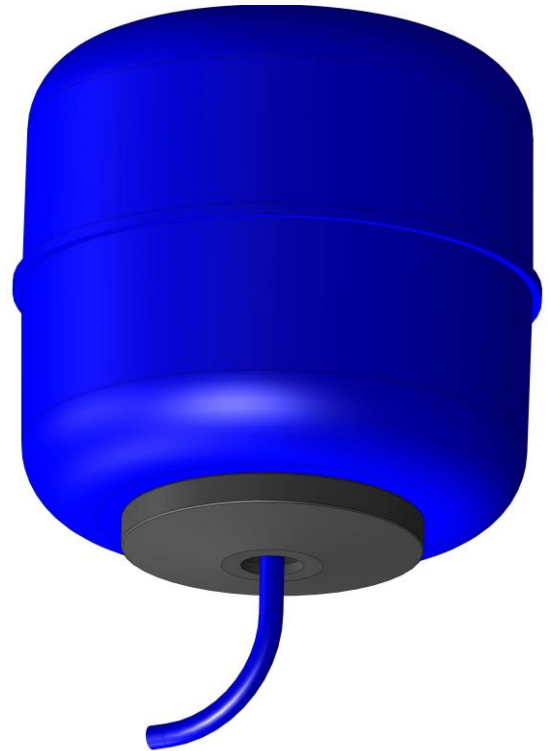

**SEE OTHER WARNINGS AND IMPORTANT INFORMATION IN THE PRODUCT MANUAL**

LHS = LEFT SIDE OF THE VEHICLE WHEN FACING FORWARD

### STEP 1 - AIR LINE TUBING & FITTINGS - GENERAL NOTES

#### CUTTING

Only cut the airline tubing with a sharp blade making the cut as square as possible.  
Always trim the tubing before re-inserting into the fitting.

- ⚠** If you use a sharp utility knife or razor blade great care must be taken in all cases not to cut yourself during this operation.

#### CONNECTING & REMOVING

##### To connect:

Push the freshly trimmed tubing into the fitting as far as possible.

##### To remove:

First release the air pressure from the system. To withdraw the tubing, push and hold the collar on the fitting away from the tube and pull out the tubing.

**Hint** In confined spaces an open-ended spanner can be used to evenly depress the collar and remove the airline tubing.

**CUT TUBING SQUARE WITH SHARP BLADE OR TUBE CUTTER**

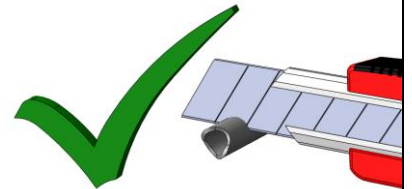

**DO NOT USE PLIERS, SIDE CUTTERS OR PIPE CUTTERS**

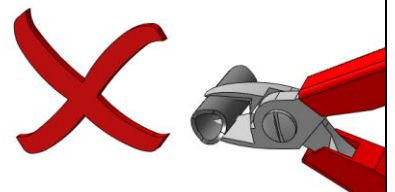

### STEP 2 - POSITION YOUR INFLATION VALVES

Select a convenient location for the air inflation valves such as the bumper or the body of the vehicle. It must be protected from road damage and be accessible for air inflation equipment.

Drill a 5/16" hole and install the air inflation valve using two 5/16" stainless steel washers as supports where required.

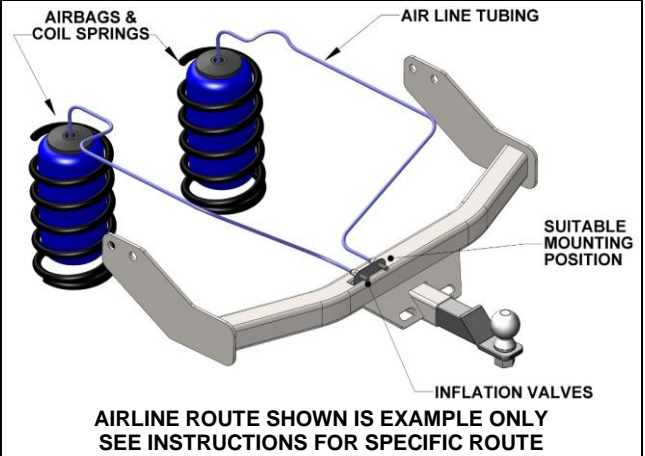
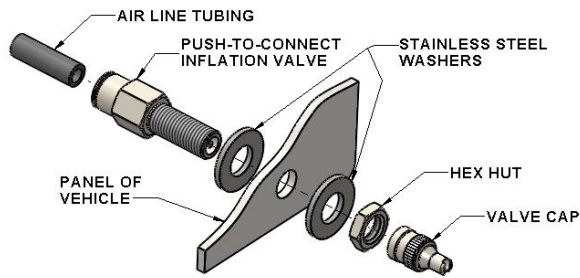

### STEP 3 - PREPARE THE AIR LINE TUBING

The airline is supplied with split protector tube pre-fitted to shield the air line during and after installation. Decide on a suitable route for the air line from the airbag to the inflation valve location to avoid direct heat from engine, exhaust pipe, and away from sharp edges.

Uncoil the air line tubing being careful not to fold or kink it and cut to length to suit the chosen route. Once routed, the protector tube is pulled back later to prepare the protected airline.

**DO NOT CONNECT OR SECURE THE AIR LINE AT THIS POINT**



### STEP 4 - ADD THE HIGH PRESSURE SLEEVES

**IMPORTANT: Complete initial airbag and sleeve inflation at ride height. This will allow the airbag and sleeve to mate together in the correct suspension position.**

Fit the elasticated tapered end of the High Pressure sleeve over the airbag and slide the High Pressure sleeve over the airbag as shown. The High Pressure sleeve is to be positioned with the tapered ends neatly over the upper and lower shoulders of the airbag as shown.

**Note: Fitting airbags with high pressure sleeves will increase the material thickness to be inserted into the coil. Airbag Man recommend coil isolators be removed to help with airbag and sleeve installation.**



### STEP 5 - PREPARE THE VEHICLE

To fit this kit, the coil springs need to be removed. Ensure this operation is carried out according to the vehicle manufacturers instructions.

### STEP 6 - DRILL LOWER SPRING SEAT

Drill the lower spring seat hole out to 19mm, clean any burrs or sharp edges.



### STEP 7 - JOUNCE BUMPER REMOVAL

The jounce bumper will need to be removed from its cup, levering by hand then cut down to 20mm. Once cut down re install into cup.



### STEP 8 - ROUTE THE AIRLINE TUBING INTO THE COIL SPACE

Route the airline tubing through the lower coil spring seat with enough extra to protrude through the coil space for airbag connection and test. Ensure that the protector sleeve is passed over the airline into the jounce bumper mount.

### STEP 9 - RED PLUGS

Use of the red plugs supplied is optional. They will enable a general reduction in airbag size which may be required to ease an airbag into a coil spring which is out of the vehicle, and they will fully flatten an airbag for easy insertion into an in-situ extended coil spring through the winding.

**USING RED PLUGS:** Flatten the airbag with the airline fitted and plug the other end of the airline tubing with the red plug. The airbag should now remain flattened whilst you perform fitment into the coil spring.



### STEP 10 - INSERT AIRBAG INTO COIL SPRING

Insert the airbag into coil spring with the air inlet at the bottom.

### STEP 11 - INSERT LOWER SUPPORT

Insert a protector into the coil space and place on the airbag so that the central countersunk hole faces the airbag.

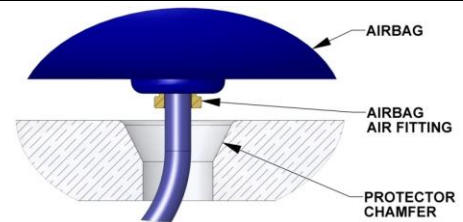

### STEP 12 - HIGH PRESSURE SLEEVE POSITIONING

Once the airbag and high pressure sleeves are in the coil spring it is recommended that you visually inspect to ensure correct positioning. You can work the high pressure sleeve around the airbag so that it is as even as possible prior to inflating the airbag.

### STEP 13 - CONNECT AIRLINE TUBING AND TEST CONNECTIONS

**CONNECT** the airline tubing by inserting one end into the airbag air fitting, the other end into the installed inflation valve.

**Hint** Flat nose pliers may be used to lightly grip the airline tubing to ensure it is fully inserted into the airbag fitting.

**INFLATE** the airbag to the maximum allowed pressure (see Specific Airbag Operating Pressures) and check for leaks at the connections using soapy water spray. We recommend a soapy water spray solution of 25% soap to 75% water.

**DEFLATE** the airbag. If no leak, continue. If leak detected, remove the airline tubing, re-cut and re-test.

**CHECK** airbag is not in contact with any sharp edges or is too close to exhaust heat in all load and height conditions.

#### STEP 14 - COIL SPRING RE FITMENT

Re install the coil spring with the airline connected to the airbag and through the protector. Ensure the airline does not get crushed or kinked when feeding the coil back into its original position. Attach all suspension components removed earlier and return the vehicle to driving position. Ensure this operation is carried out according to the vehicle manufacturer's instructions.



#### STEP 15 - ROUTE AIRLINE TUBING

Route the airline tubing through the bottom of the coil spring far enough for airbag connection, ensuring it passes through the protector and the protector orientation is correct. Follow handbrake cable and wiring looms, keeping clear of any sharp edges and heat back to the inflation valves.

#### STEP 16 - PREPARE HEAT SHIELD

Select the heat shield from the kit and bend the legs as shown, bending by hand is OK. Offer up the heat shield to the position where the exhaust pipe passes closest to the airbag, and, if necessary, bend the shield to the exhaust shape.

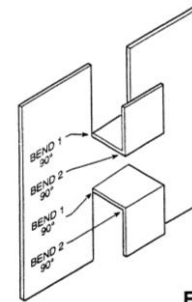

Figure "A"

#### STEP 17 - START HEAT SHIELD CLAMPS

Select the two work drive clamps from the kit, and undo them completely, then slip over the pipe and re-start. Position the clamps so that you can do them up to hold the shield, as shown,

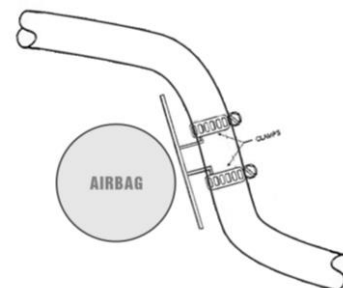

FIGURE "B"

#### STEP 18 - FIT HEAT SHIELD

Fit the heat shield to the pipe using the clamps and position the shield to provide an air space between it and the pipe, whilst protecting the airbag.

**⚠ Exhaust modifications from standard or incorrect fitment can cause eventual heat damage issues.**

- Should you have the exhaust system modified this may result in increased heat exposure to the airbags, which may reduce the life span. Please contact Airbag Man before any exhaust modifications are carried out.

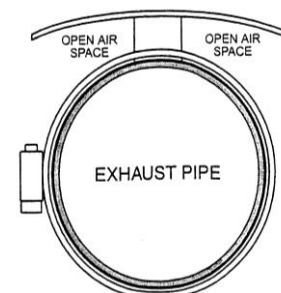

Figure "C"

#### STEP 19 - INSTALL COMPLETION

Return the vehicle to original driving position. Ensure this operation is carried out according to the vehicle manufacturer's instructions.



**STEP 20 - TO FINISH**

Ensure the **WARNING** label is fixed in a prominent position in sight of the vehicle operator.

Ensure the Product Information Wallet is given to the vehicle owner/operator.

Ensure the vehicle owner/operator fully understands how to use the product.

All fixings should be checked for tightness after the first laden run and thereafter as per the original manufacturer's recommendations.

***SPECIFIC AIRBAG OPERATING PRESSURES***

See operating instructions section for proper use and apply the specific pressures below:

<b><i><u>STANDARD KIT WITHOUT HP SLEEVES</u></i></b>	<b><i><u>HIGH PRESSURE KIT WITH HP SLEEVES</u></i></b>
<b><u>MINIMUM</u></b> <b>5 PSI (0.4 bar)</b>	<b><u>MINIMUM</u></b> <b>5 PSI (0.4 bar)</b>
<b><u>MAXIMUM</u></b> <b>30 PSI (2 bar)</b>	<b><u>MAXIMUM</u></b> <b>60 PSI (4.1 bar)</b>

Adjust and maintain pressure up to the stated maximum to level the vehicle for the load imposed and always maintain the minimum airbag pressure.

Failure to do so may result in product or vehicle damage not covered under warranty.

**IF MORE PRESSURE IS REQUIRED TO LEVEL THE VEHICLE  
CALL AIRBAG MAN ON 1800 247 224 FOR FURTHER TECHNICAL ADVICE**



**FREECALL 1800 247 224**



**⚠️ Incorrect use of this air suspension product can result in damage to the airbag, associated parts and/or the vehicle, which is not covered under warranty.**

**⚠️ Ensure the airbags are maintained at the stated ride height at all times and the maximum pressure is never exceeded.**